

(LOW1.LOW) 16147

TARGY ONE DEPARTURE (OBSTACLE)

SL-632 (FAA)

YELLOWSTONE (WYS)
WEST YELLOWSTONE, MONTANA

SALT LAKE CENTER
132.4 338.30
CTAF
123.0

TARGY
415 LO 
N44°34.49'
W111°11.76'
10100

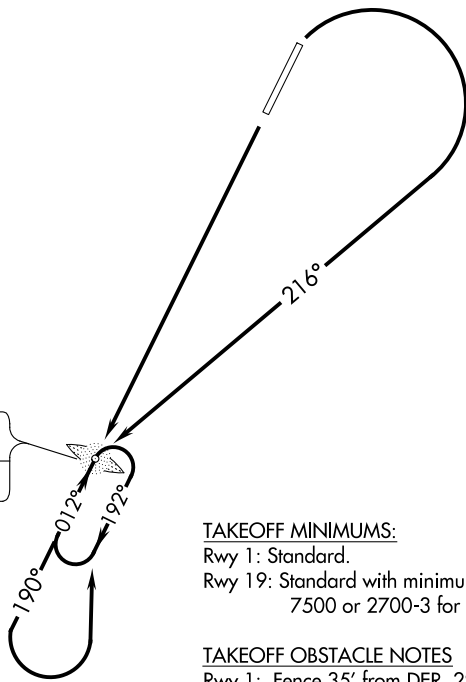

TAKEOFF MINIMUMS:

Rwy 1: Standard.

Rwy 19: Standard with minimum climb of 270'/NM to 7500 or 2700-3 for climb in visual conditions.

TAKEOFF OBSTACLE NOTES

Rwy 1: Fence 35' from DER, 298' left of centerline, 14' AGL/6635' MSL.

Rwy 19: Tree 487' from DER, 581' right of centerline, 17' AGL/6665' MSL.

NOTE: ADF required.

NOTE: RADAR required.

NOTE: Chart not to scale.

DEPARTURE ROUTE DESCRIPTION

TAKEOFF RUNWAY 1: Climbing right turn to intercept course 216° to TARGY LOM, then on bearing 190° outbound and a left turn direct to cross TARGY LOM at or above 10100. Thence. . .

TAKEOFF RUNWAY 19: Climb direct to TARGY LOM then outbound bearing 190° and a left turn direct to cross TARGY LOM at or above 10100. Thence..or climb in visual conditions to cross Yellowstone Airfield at or above 9200, then direct TARGY LOM at or above 10100. Thence. . .

. . .continue climb in holding to 12000 at TARGY LOM (Hold S, RT 012° inbound), expect RADAR vectors with Salt Lake Center.

TARGY ONE DEPARTURE (OBSTACLE)

(LOW1.LOW) 09FEB12

WEST YELLOWSTONE, MONTANA
YELLOWSTONE (WYS)

NW-1, 12 OCT 2017 to 09 NOV 2017

NW-1, 12 OCT 2017 to 09 NOV 2017